

Madison Flair

Kombinationsbeispiel 1

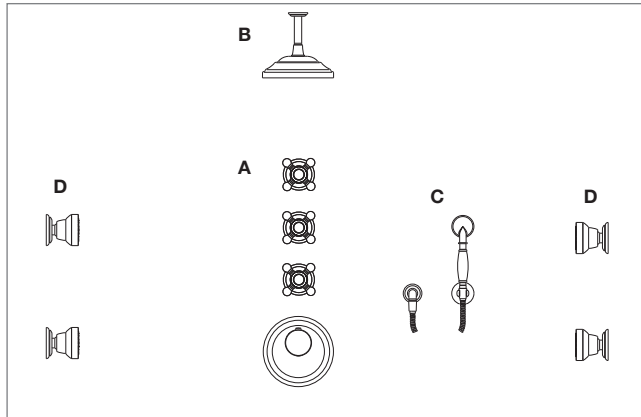

Regeleinheit

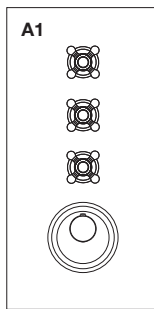

A1	1x	36 416 977-FF
	3x	36 310 360-FF
	1x	35 546 970 90

Kopfbrause

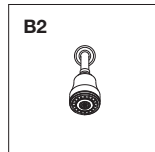
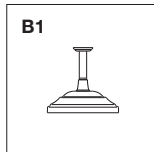

B1	1x	28 565 977-FF
B2	1x	28 508 360-FF
B3	1x	28 545 977-FF
	1x	12 555 970-FF*
B4	1x	28 555 977-FF
	1x	12 555 970-FF*

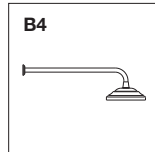
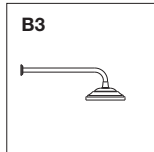

Handbrause

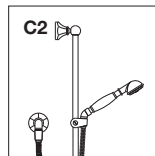
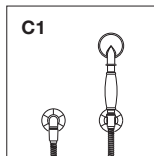

C1	1x	27 803 370-FF
C2	1x	26 403 370-FF
	1x	28 450 370-FF

Seitenbrausen

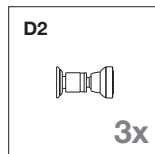
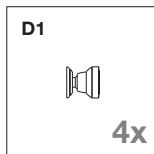

D1	4x	28 518 360-FF
D2	3x	28 519 360-FF

Kombinationsbeispiel 2

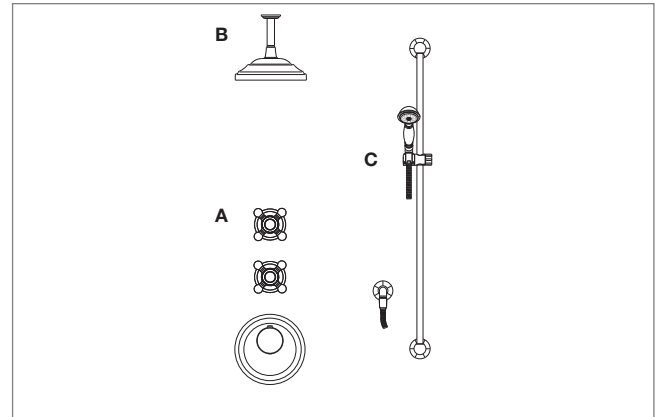

Regeleinheit

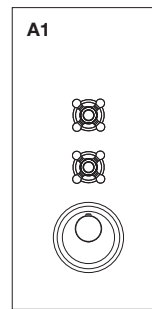

A1	1x	36 416 977-FF
	2x	36 310 360-FF
	1x	35 526 970 90

Kopfbrause

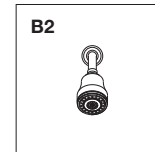
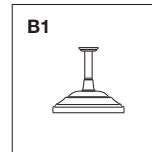

B1	1x	28 565 977-FF
B2	1x	28 508 360-FF
B3	1x	28 545 977-FF
	1x	12 555 970-FF*
B4	1x	28 555 977-FF
	1x	12 555 970-FF*

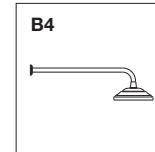
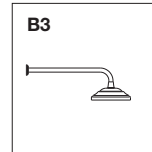

Handbrause

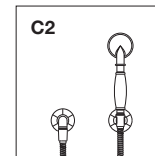
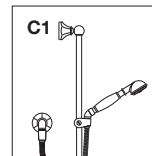

C1	1x	26 403 370-FF
	1x	28 450 370-FF
C2	1x	27 803 370-FF



Kombinationsbeispiel 3

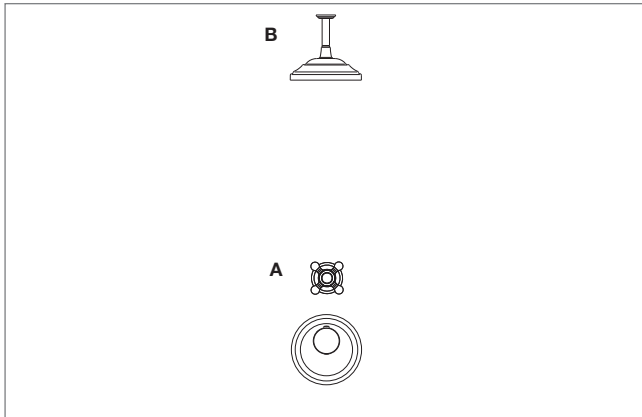

Regeleinheit

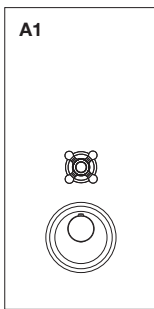

- A1** 1x **36 416 977-FF**
- 1x **36 310 360-FF**
- 1x **35 436 970 90**

Brause

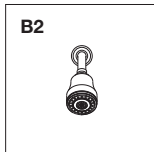
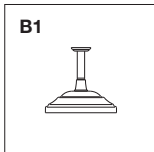

- B1** 1x **28 565 977-FF**
- B2** 1x **28 508 360-FF**

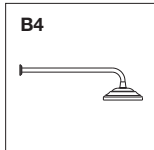
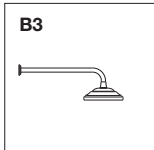

- B3** 1x **28 545 977-FF**
- 1x **12 555 970-FF***

- B4** 1x **28 555 977-FF**
- 1x **12 555 970-FF***

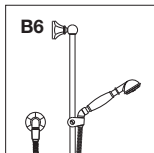
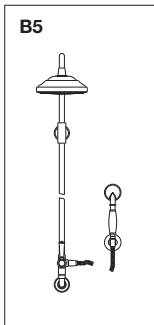

- B5** 1x **27 603 360-FF**

- B6** 1x **26 403 370-FF**
- 1x **28 450 370-FF**

Kombinationsbeispiel 4

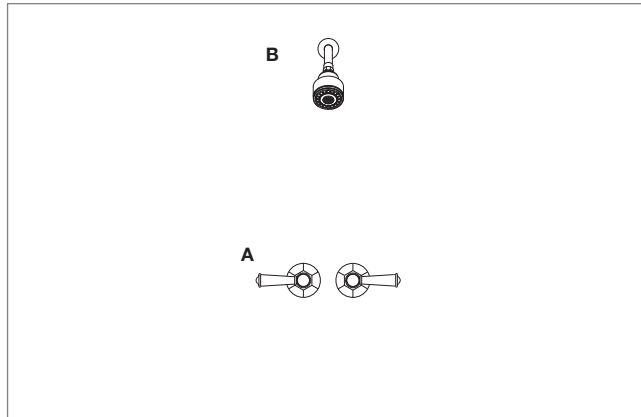

Regeleinheit

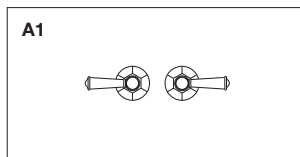

- A1** 2x **36 310 370-FF**
- 2x **11 170 370-FF**
- 1x **35 621 970 90**
- 1x **35 671 970 90**

Brause

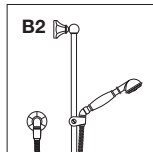
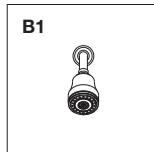

- B1** 1x **28 508 360-FF**
- B2** 1x **26 403 370-FF**
- 1x **28 450 370-FF**